

1.

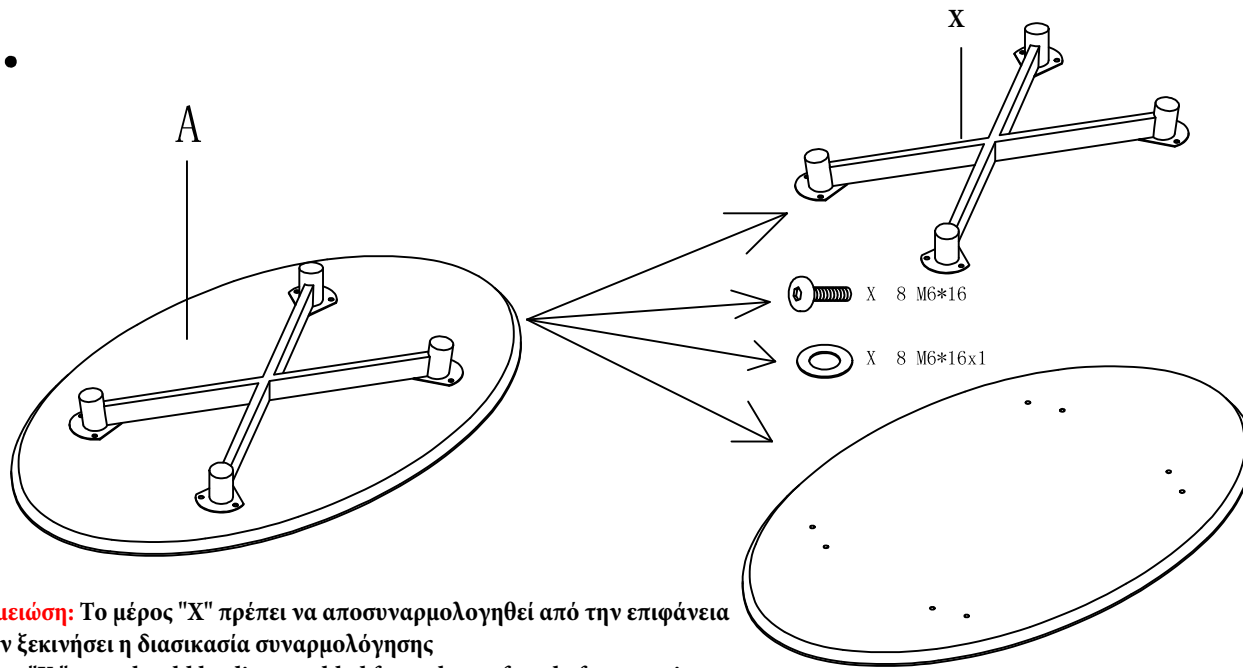

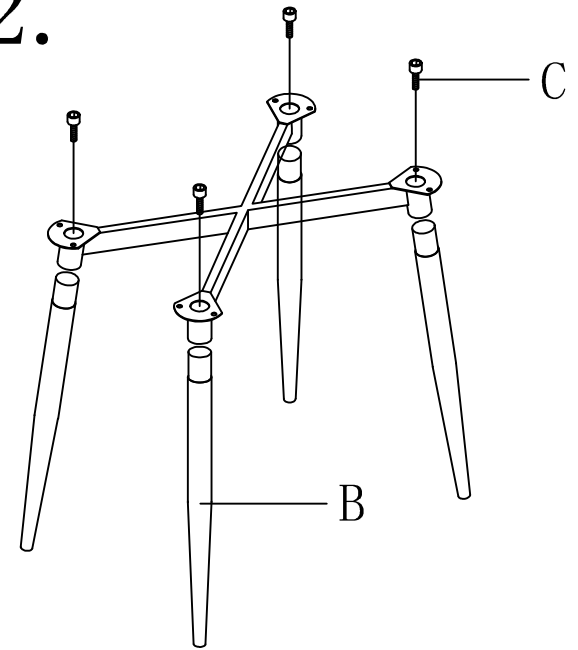



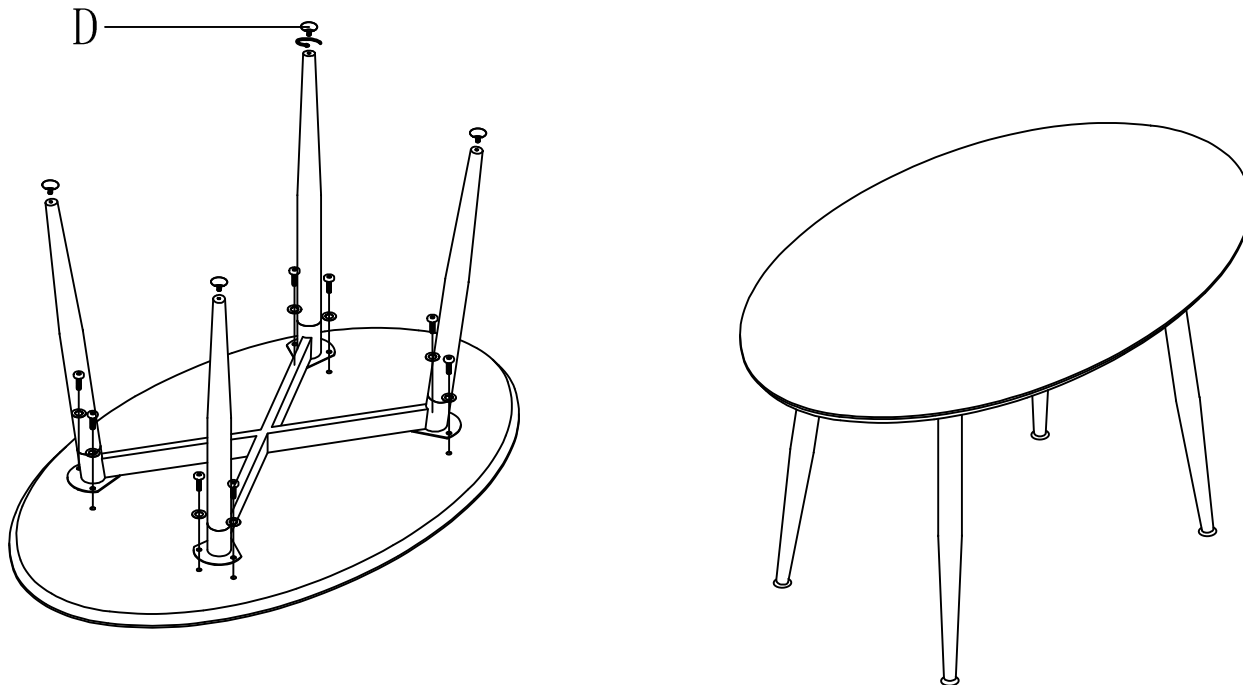

**Σημείωση:** Το μέρος "X" πρέπει να αποσυναρμολογηθεί από την επιφάνεια πριν ξεκινήσει η διαδικασία συναρμολόγησης  
**Note:** "X" part should be disassembled from the surface before starting the procedure of assembly

2.

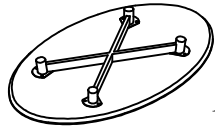

3.



A	 1PCS	B	 4PCS
C	M10*30  4PCS	D	M6*30  4PCS
E	M5  1PCS	F	M8  1PCS